

30" Tapered Meter Pit Series RMP3030-W Specifications

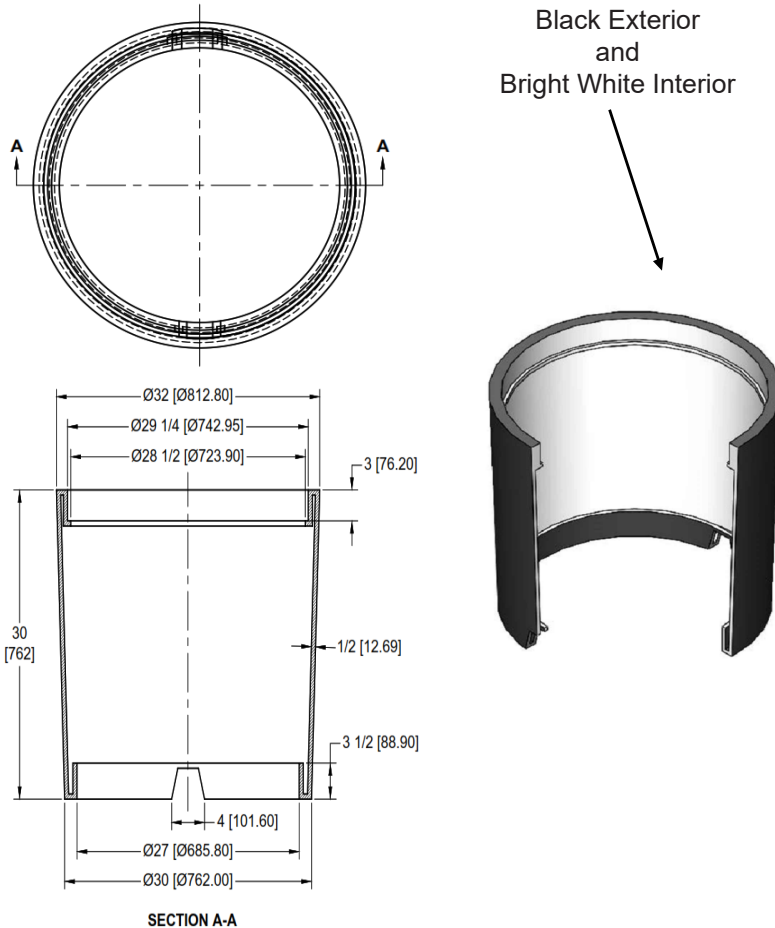

Black Exterior
and
Bright White Interior

Manufacture Process: Sigma-Raven tapered meter pits are produced using High Density Polyethylene regrind and virgin resins in a series of LAMINATED WALLS with an optional white interior coating. The outer wall is LAMINATED to the interior wall providing greater side load-bearing capacity. When the two walls are laminated together the Molecular Structure (fibers) from each wall are crossed, creating a dual layer of much greater strength and wall thickness. Wall thickness shall be such that when buried, it will support an incidental traffic load as explained with an appropriate traffic rated lid.

Impact: Impact tests shall be conducted at two different locations. These are (1) the top of pit at lid area and (2) at the center area. Failure of the test specimen shall be any crack, split or shatter of the wall section. Test using a 10-lb Tub B and flat plate Holder B. Test one pit per run if failure occurs test 3 more pits. If no failure occurs the run is approved.

Interior: Interior shall be Black or optional White.

Settling: Tapered Meter Pit shall have an integral flat a settling plate around the base.

Extension: Available in many sizes. Cut to grade or angle in field.

Thermo Flange: Located 3" from top of pit.

Base Flange: Located at the top of mouse hole to reinforce and maintain round base.

Rings & Lids: Tapered Meter Pit will accept all standard covers. (also AMR lids).

Depths Available: 20", 24", 30", 36" and 48"

- Manufactured of High Density Polyethylene in compliance with minimum AASHTO H20 loading.
- This product is designed to withstand minimum H20 loading in non-deliberate or incidental traffic areas such as driveways, parking lots and off-road applications.

